



MPFIC-U-28-HT
Isolated PFC Module
Half-brick

Military Isolated Power Factor Correction Module

85-264Vrms Input Voltage	47 - 63Hz / 360 - 800Hz Input Frequency	28Vdc Output Voltage	11.5A Output Current	≥0.99 Power Factor	90%@115Vrms / 92%@230Vrms Full Load Efficiency
------------------------------------	---	--------------------------------	--------------------------------	------------------------------	--

The MPFICQor Military Isolated PFC Module is a high power, high efficiency AC-DC converter. It operates from a universal AC input and generates an isolated output. Both regulated and semi-regulated (droop version) modules are available. Used in conjunction with a hold-up capacitor, and SynQor’s MCOTS AC line filter, the MPFICQor will draw a nearly perfect sinusoidal current (PF>0.99) from a single phase AC input. The module is supplied completely encased to provide protection from the harsh environments seen in many military and aerospace environments.

MPFICQor™



Designed and manufactured in the USA

Operational Features

- Isolated output, 325W output power
- Universal input frequency range: 47 - 63Hz / 360 - 800Hz
- Input voltage range: 85-264Vrms
- ≥0.99 Power Factor
- High efficiency: 92% (230Vrms)
- Internal inrush current limit
- Auxiliary 10V bias supply, primary-side referenced
- Can be paralleled (droop version only)
- Compatible with SynQor’s MCOTS AC line filters

Mechanical Features

- Industry standard half-brick package
- Size: 2.386" x 2.486" x 0.512" (60.6 x 63.1 x 13.0 mm)
- Total weight: 4.8 oz (136 g)
- Flanged baseplate version available

Protection Features

- Input current limit and auto-recovery short circuit protection
- Auto-recovery input under/over-voltage protection
- Auto-recovery over-voltage protection
- Auto-recovery thermal shutdown

Safety Features

- Input to output reinforced isolation 4250Vdc
- Input/Output to baseplate isolation 2150Vdc
- CE Marked

Control Features

- PFC Enable
- AC Power Good Signal
- DC Power Good Signal

Compliance Features

- Designed to meet these standards when used with SynQor MACF Filters.
- MIL-STD-461(A-F)
 - MIL-STD-1399
 - MIL-STD-704-2, -704-4, & -704-6* (see 704 app section)

Contents

Typical Application	2
Technical Specification	3
Screening & Qualification Testing	7
Application Section	8
Encased Mechanical	14
Encased Mechanical with Flange	15
Ordering Information	16



MPFIC-U-28-HT
Input: 85-264Vrms
Output: 28Vdc
Current: 11.5A

Typical Application

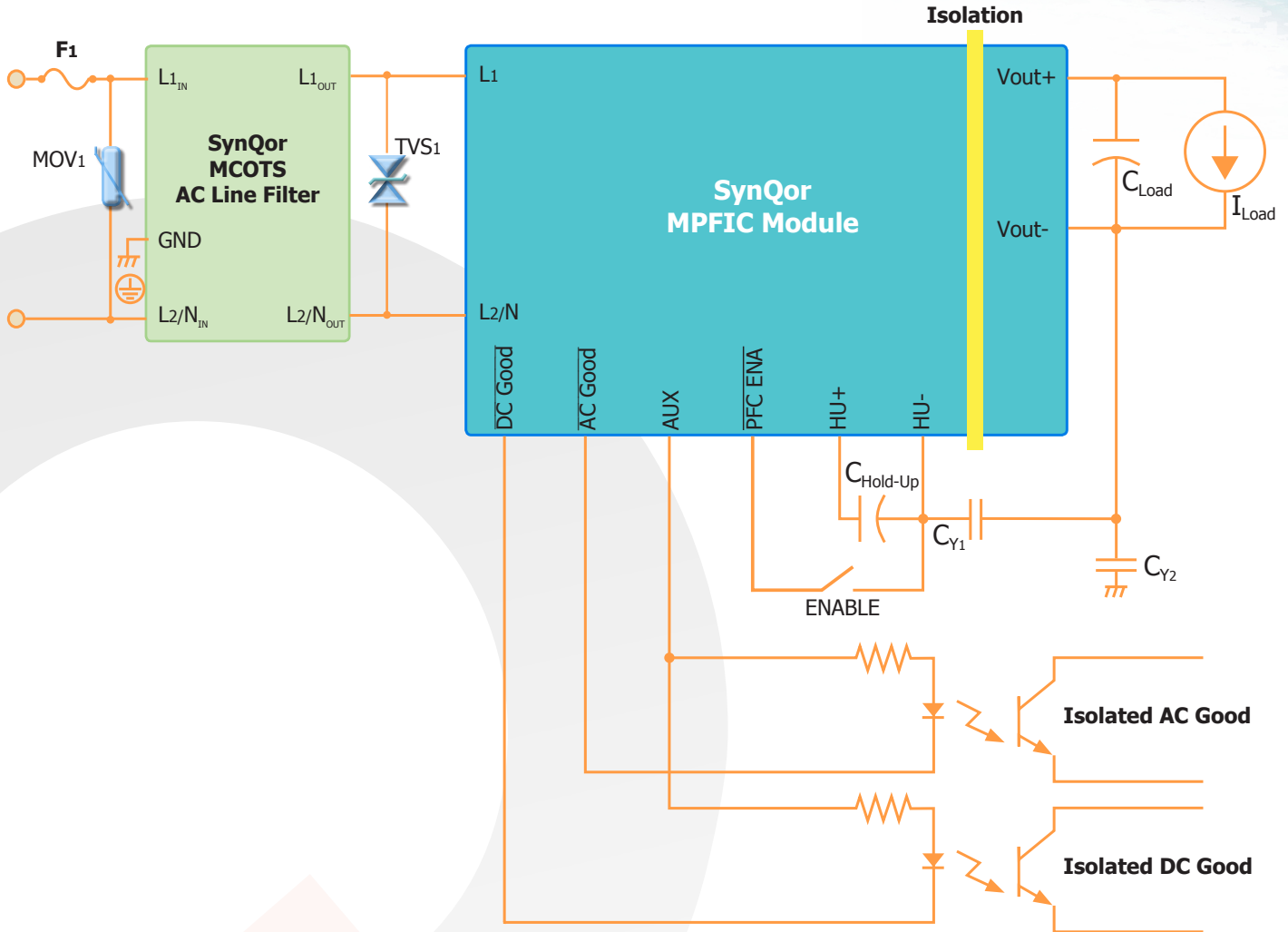

F_1 : 5A / 250V Fuse
 MOV_1, TVS_1 : Must prevent peak voltage from exceeding 575V during all transients. Must also not be acting for the desired operating range.
 $C_{Hold-Up}$: 50 - 500 μ F (Dependent on Power Level and Line Frequency)
 C_{Y1-Y2} : See "EMI Considerations" in application notes

Example Parts:
 F_1 : 250VAC, 5A; Littelfuse 0216005.MXEP
 MOV_1 : 300VAC, 60J; EPCOS S10K300E2
 TVS_1 : 400V, 3J; two VISHAY 1.5KE200CA devices connected in series
 $C_{Hold-Up}$: One 450V, 330 μ F; EPCOS B43508B5337M (-40°C)
 Two 200V, 720 μ F; Cornell Dubilier MLSG721M250EB0C **in series** with balancing resistors (-55°C)
 C_{Y1} : 3.3nF, 500VAC; Vishay VY1332M59Y5UQ6TV0
 C_{Y2} : 10nF, 300VAC; Vishay VY2103M63Y5US63V7

Figure A: Typical Application of the MPFICQor module to create an AC-DC Power Supply



MPFIC-U-28-HT
Input:85-264Vrms
Output:28Vdc
Current:11.5A

Technical Specification

MPFIC-U-28-HT Electrical Characteristics

Operating conditions of 115Vrms, 60Hz input, 11.5A output, 200µF bulk capacitance, and baseplate temperature = 25°C unless otherwise noted; full operating baseplate temperature range is -55 °C to +100 °C with appropriate power derating. Specifications subject to change without notice.

Parameter	Min.	Typ.	Max.	Units	Notes & Conditions
ABSOLUTE MAXIMUM RATINGS					
Input Voltage (L1 to L2/N)			575	Vpk	
Isolation Voltage (Input to Output)			4250	Vdc	See Note 3
Isolation Voltage (Input/Output to Baseplate)			2150	Vdc	See Note 3
Operating Temperature	-55		100	°C	Baseplate temperature
Storage Temperature	-65		135	°C	
Voltage at AC GOOD and pins	-0.3		16	V	Referenced to HU-
Voltage at DC GOOD and pins	-0.3		16	V	Referenced to HU-
Current drawn from AUX pin	0		10	mADC	
Voltage at PFC enable pin	-2		575	V	Referenced to HU-
INPUT CHARACTERISTICS (L1 to L2/N)					
Operating Input Voltage Range					
AC Input Continuous	85		264	Vrms	Available output power reduced when <90 Vrms
AC Input 100ms Transient	40		290	Vrms	
Input Under-Voltage Lockout		30		Vrms	>1s duration
Input Over-Voltage Shutdown		440		Vpk	
Operating Input Frequency	47		63	Hz	50/60Hz range, for startup
	360		800	Hz	400Hz range, for startup
	45		800	Hz	After startup, unit operates over wide frequencies
Power Factor of AC Input Current		0.99			50/60Hz, min 200W output
		0.97			400Hz, min 200W output
Total Harmonic Distortion of AC Input Current		3		%	
Inrush of AC Input Current					When used with SynQor AC line filter
50/60Hz			10	Apk	
400Hz			20	Apk	
Enabled AC Input Current (no load)		100	180	mArms	115 Vrms input
Disabled AC Input Current		30	50	mArms	
Maximum Input Power			385	W	
Maximum Input Current			4.8	Arms	85 Vrms input
OUTPUT CHARACTERISTICS					
Output Voltage Set Point at Full Load					See Figure 6 for V-I curve
Standard Option	27.6	28.0	28.4	Vdc	Vin<250Vrms, for higher Vin see application notes
-D Option	26.3	27.0	27.3	Vdc	
Total Output Voltage Range					See Figure 6 for V-I curve
Standard Option	27.3		28.7	Vdc	Vin<250Vrms, for higher Vin see application notes
-D Option	26.0		29.0	Vdc	
Standard Option Voltage Regulation					Above half load
Over Line		±0.3		%	Vin<250Vrms, for higher Vin see application notes
Over Load			0.5	%	
Over Temperature	-1.5		240	mV	
Output Voltage Ripple and Noise					60Hz, see Note 1
Peak-to-Peak			3.0	%	With 200µF hold-up capacitance, full load at 60Hz
RMS			1.2	%	
Operating Output Current Range	0		11.5	A	
Output Current Limit					Unit continues to operate for 1s before shutdown
115 Vrms		13.0		A	
230 Vrms		14.5		A	
Maximum Output Capacitance			2,000	µF	At half resistive load
HOLD-UP CHARACTERISTICS					
Typical Hold-up Voltage		400		Vdc	
Hold-up Voltage Range	385		415	Vdc	Hold-up voltage varies with load
Hold-up Over-Voltage Protection Threshold	440		460	Vdc	
Hold-up Under-Voltage Shutdown Threshold		200		Vdc	
Hold-up Capacitance	50		500	µF	See Note 2
External Common-Mode Capacitance			20	nF	See "EMI Considerations" in application notes
Efficiency					
100% Load at 115Vrms		90		%	See Figure 1 for efficiency curve
100% Load at 230Vrms		92		%	See Figure 1 for efficiency curve

Note 1: 200µF electrolytic hold-up capacitor having a typical ESR of 0.5Ω. Ripple amplitude dependent on capacitance and ESR of hold-up capacitor.

Note 2: The MPFICQor is able to operate with a minimum of 50µF of hold-up capacitance, but SynQor recommends at least 330µF if the power system will be required to conform to lightning surge standards. This is because the MPFICQor relies on the hold-up capacitor to absorb the energy from a lightning surge.



MPFIC-U-28-HT
Input:85-264Vrms
Output:28Vdc
Current:11.5A

Technical Specification

MPFIC-U-28-HT Electrical Characteristics (continued)

Operating conditions of 115Vrms, 60Hz input, 11.5A output, 200µF bulk capacitance, and baseplate temperature = 25°C unless otherwise noted; full operating baseplate temperature range is -55 °C to +100 °C with appropriate power derating. Specifications subject to change without notice.

Parameter	Min.	Typ.	Max.	Units	Notes & Conditions
DYNAMIC CHARACTERISTICS					
Turn-On Transient					
Start-up Inhibit Time		10		ms	
Turn-On Time		2		s	
Output Voltage Overshoot		0	2	%	
ISOLATION CHARACTERISTICS (Input to output)					
Isolation Test Voltage (Dielectric Strength)					See Absolute Maximum Ratings, Note 3
Isolation Resistance	100			MΩ	
Isolation Capacitance		100		pF	
ISOLATION CHARACTERISTICS (Input/output to baseplate)					
Isolation Test Voltage (Dielectric Strength)					See Absolute Maximum Ratings, Note 3
Isolation Resistance	100			MΩ	
Isolation Capacitance		100		pF	
TEMPERATURE LIMITS FOR POWER DERATING CURVES					
Semiconductor Junction Temperature			125	°C	
Board Temperature			125	°C	
Transformer Temperature			125	°C	
Maximum Baseplate Temperature, T _B			100	°C	
FEATURE CHARACTERISTICS					
Hold-up Capacitor Precharge					
Precharge Current		50		mA	
Hold-up Short-Circuit Withstand			indefinite	s	
Free Running Switching Frequency		250		kHz	
PFC Enable (PFC ENA)					Referenced to HU-
Off-State Voltage	2			V	
On-State Voltage			0.8	V	
Internal Pull-Up Voltage		5		V	
Internal Pull-Up Resistance		10		kΩ	
AC Good (AC GOOD)					Referenced to HU-
AC Input Voltage for AC Good	119		375	Vpk	
Pull-down resistance			20	Ω	Open collector
DC Good (DC GOOD)					Referenced to HU-
Pull-down resistance			20	Ω	Open collector
Over-Temperature Trip Point		130		°C	At internal PCB
Auxiliary Bias Supply					
Voltage Range (≤3 mA Load)	7		12	V	Referenced to HU-
Maximum Source Current			10	mA DC	
Equivalent Series Resistance		1		kΩ	
RELIABILITY CHARACTERISTICS					
Calculated MTBF (MIL-217) MIL-HDBK-217F		840		kHrs	Ground Benign, T _B = 70°C
Calculated MTBF (MIL-217) MIL-HDBK-217F		130		kHrs	Ground Mobile, T _B = 70°C

Note 3: 1 minute for qualification test, and less than 1 minute in production.



Technical Specification

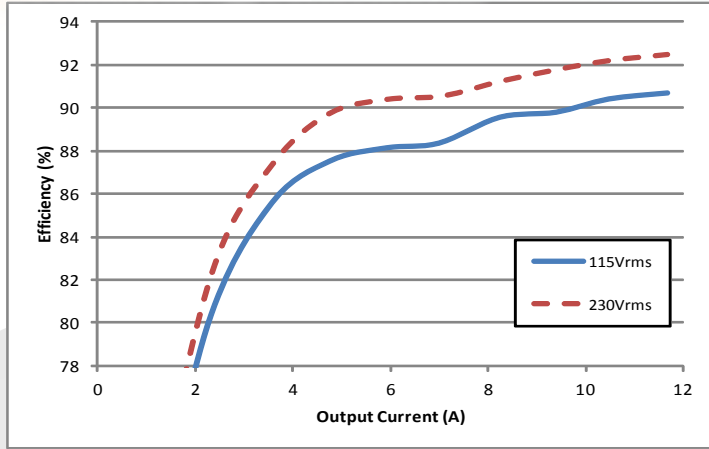

Figure 1: Efficiency at nominal output voltage vs. output current for 115Vrms and 230Vrms (60Hz) input voltage at $T_b = 25^\circ\text{C}$.

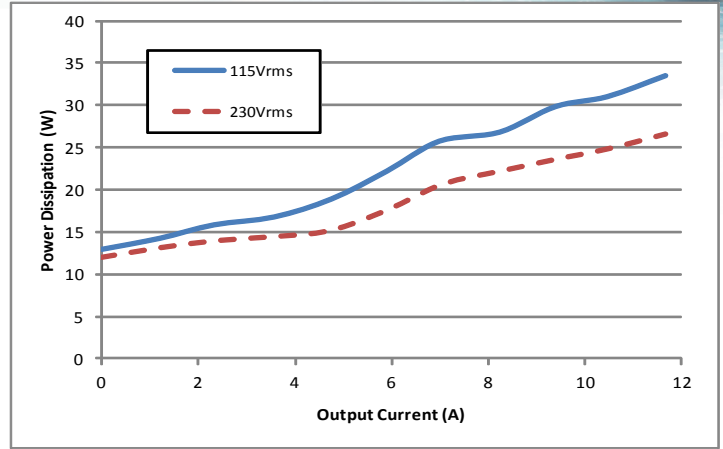

Figure 2: Power dissipation at nominal output voltage vs. output current for 115Vrms and 230Vrms (60Hz) input voltage at $T_b = 25^\circ\text{C}$.

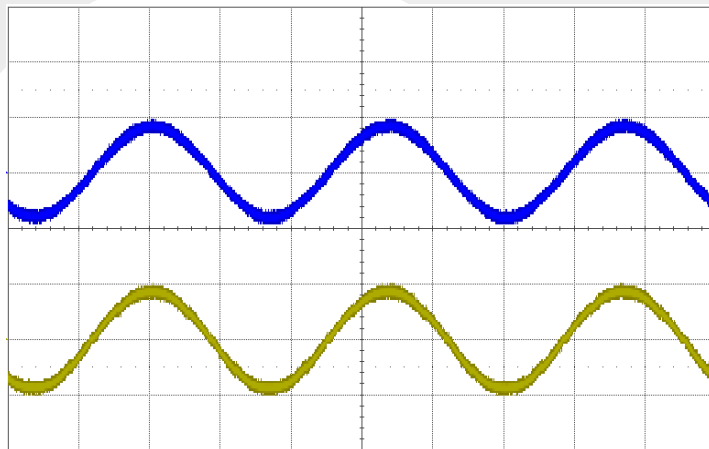

Figure 3: Typical Input Voltage and Current waveforms at full load current (115Vrms, 60Hz). Top: V_{in} (200V/div), Bottom: I_{in} (5A/div), Timebase: (5ms/div).

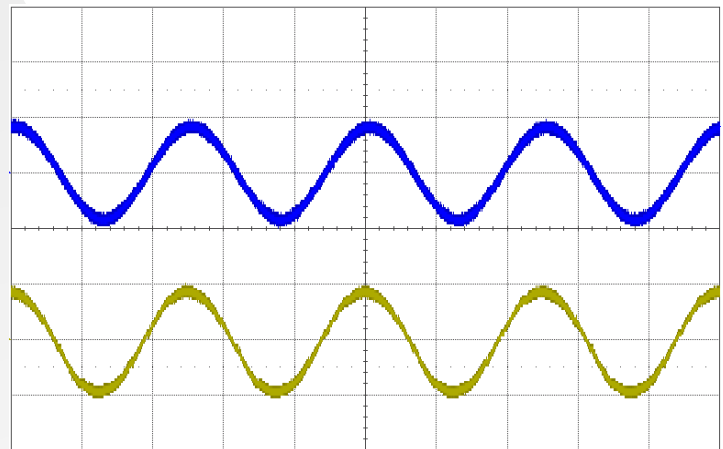

Figure 4: Typical Input Voltage and Current waveforms at full load current (115Vrms, 400Hz). Top: V_{in} (200V/div), Bottom: I_{in} (5A/div), Timebase: (1ms/div).

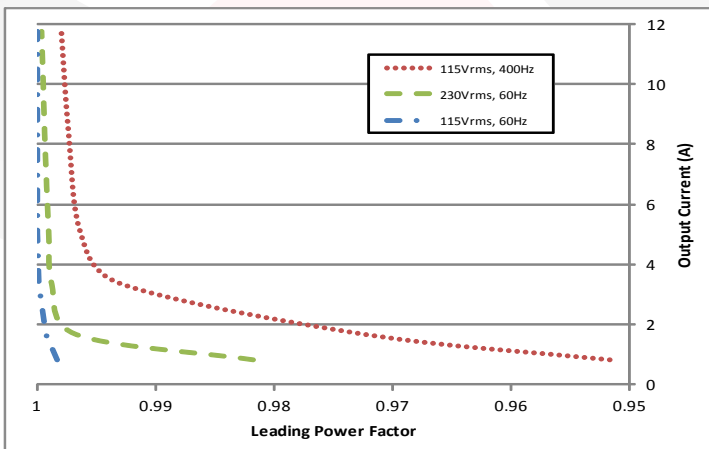

Figure 5: Output current vs. leading power factor, MPFIC module only (no input filter).

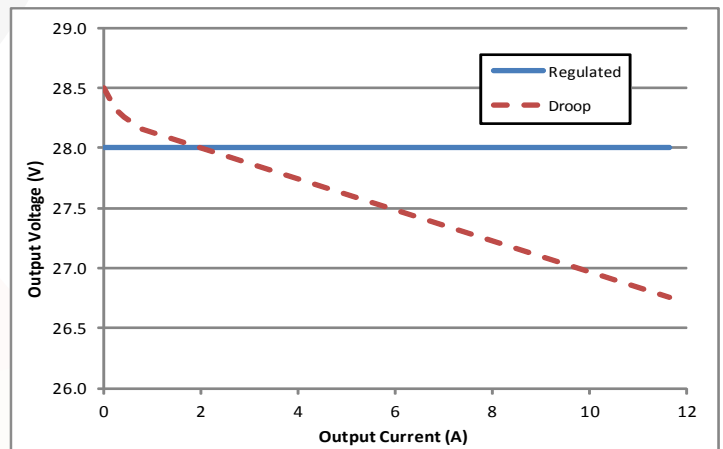

Figure 6: Typical output voltage vs. output current for regulated and droop version outputs.



Technical Specification

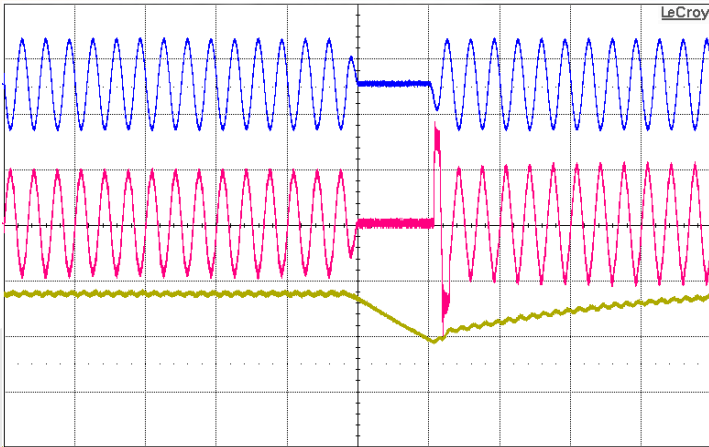

Figure 7: Line drop out with 400µF hold-up capacitor at full load current (115Vrms, 60Hz) Top: Vin (200V/div), Mid: Iin (5A/div), Bottom: Vout (10V/div), Timebase: (50ms/div).

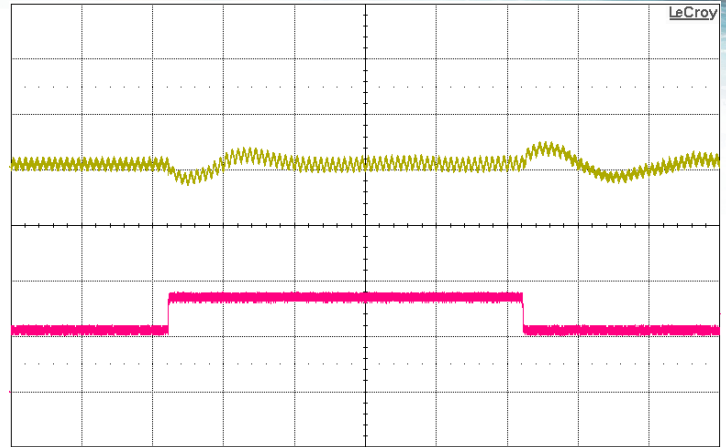

Figure 8: Output voltage response to step-change in load current with 200µF hold-up capacitor (50%-75%-50% of Iout(max), 115Vrms, 60Hz) Top: Vout (2V/div), Bottom: Iout (5A/div), Timebase: (100ms/div).

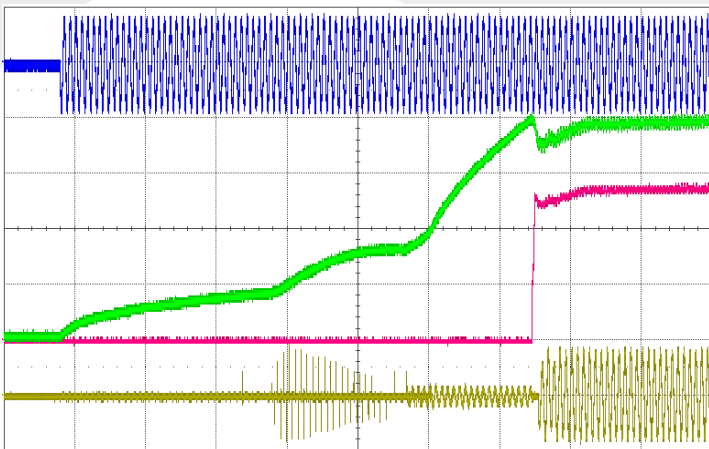

Figure 9: Typical startup waveform with 200µF hold-up capacitor (115Vrms, 60Hz) Top: Vin (200V/div), Ch2: Hold-up capacitor voltage (100V/div), Ch3: Vout (10V/div), Bottom: Iin (5A/div), Timebase: (200ms/div).

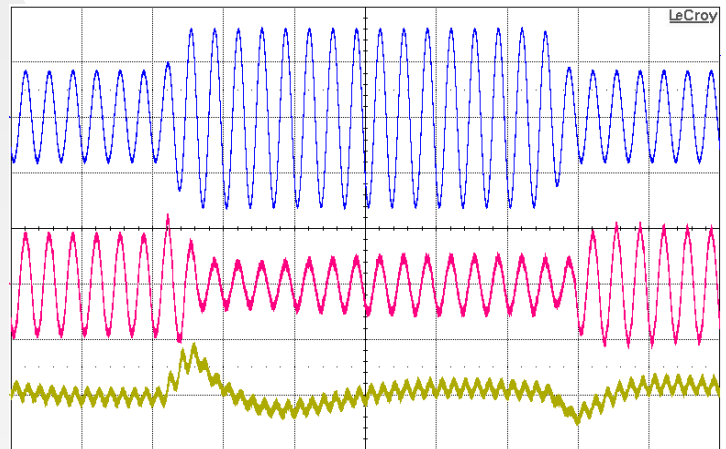

Figure 10: Input voltage transient response with 200µF hold-up capacitor at full load current (115Vrms-230Vrms-115Vrms, 60Hz), Top: Vin (200V/div), Mid: Iin (5A/div), Bottom: Vout (2V/div), Timebase: (50ms/div).

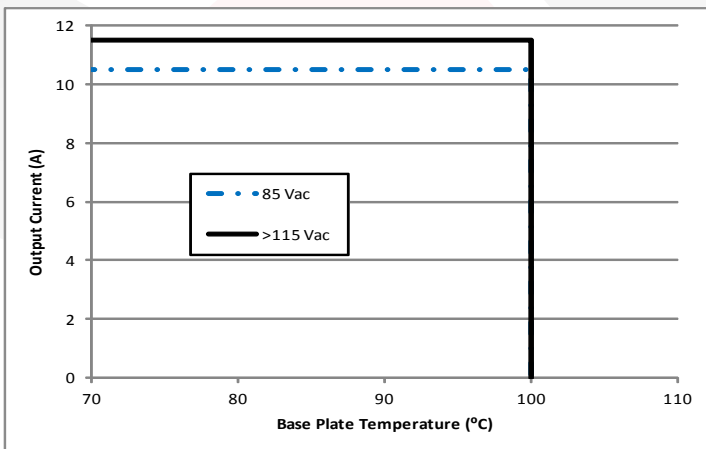

Figure 11: Maximum output current vs. base plate temperature derating curve.

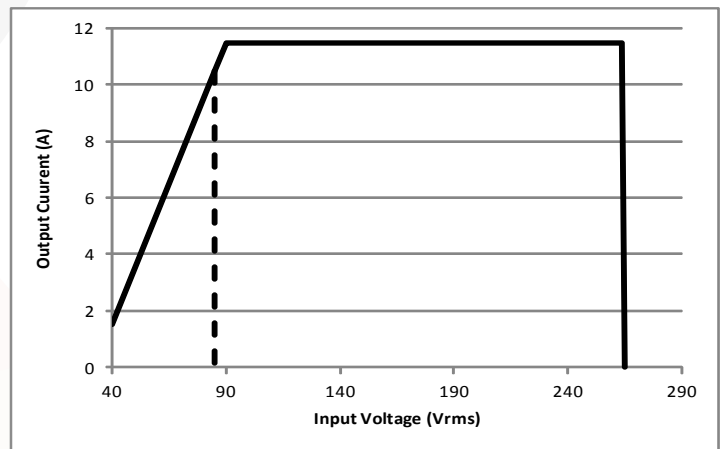

Figure 12: Maximum output current vs. input voltage, output turn-on threshold is 85Vrms.



MPFIC-U-28-HT
Input: 85-264Vrms
Output: 28Vdc
Current: 11.5A

Screening & Qualification Testing
Mil-COTS Qualification

Test Name	Details	# Tested (# Failed)	Consistent with MIL-STD-883F Method
Life Testing	Visual, mechanical and electrical testing before, during and after 1000 hour burn-in @ full load	15 (0)	Method 1005.8
Shock-Vibration	Visual, mechanical and electrical testing before, during and after shock and vibration tests	5 (0)	MIL-STD-202, Methods 201A & 213B
Humidity	+85 °C, 95% RH, 1000 hours, 2 minutes on / 6 hours off	8 (0)	Method 1004.7
Temperature Cycling	500 cycles of -55 °C to +100 °C (30 minute dwell at each temperature)	10 (0)	Method 1010.8, Condition A
Solderability	15 pins	15 (0)	Method 2003
DMT	-65 °C to +110 °C across full line and load specifications in 5 °C steps	7 (0)	
Altitude	70,000 feet (21 km), see Note	2 (0)	

Note: A conductive cooling design is generally needed for high altitude applications because of naturally poor convective cooling at rare atmospheres.

Mil-COTS Converter and Filter Screening

Screening	Process Description	S-Grade	M-Grade
Baseplate Operating Temperature		-55 °C to +100 °C	-55 °C to +100 °C
Storage Temperature		-65 °C to +135 °C	-65 °C to +135 °C
Pre-Cap Inspection	IPC-A-610, Class III	•	•
Temperature Cycling	MIL-STD-883F, Method 1010, Condition B, 10 Cycles		•
Burn-In	100 °C Baseplate	12 Hours	96 Hours
Final Electrical Test	100%	25 °C	-55 °C, +25 °C, +100 °C
Final Visual Inspection	MIL-STD-883F, Method 2009	•	•

Mil-COTS MIL-STD-810G Qualification Testing

MIL-STD-810G Test	Method	Description
Fungus	508.6	Table 508.6-I
Altitude	500.5 - Procedure I	Storage: 70,000 ft / 2 hr duration
	500.5 - Procedure II	Operating: 70,000 ft / 2 hr duration; Ambient Temperature
Rapid Decompression	500.5 - Procedure III	Storage: 8,000 ft to 40,000 ft
Acceleration	513.6 - Procedure II	Operating: 15 g
Salt Fog	509.5	Storage
High Temperature	501.5 - Procedure I	Storage: 135 °C / 3 hrs
	501.5 - Procedure II	Operating: 100 °C / 3 hrs
Low Temperature	502.5 - Procedure I	Storage: -65 °C / 4 hrs
	502.5 - Procedure II	Operating: -55 °C / 3 hrs
Temperature Shock	503.5 - Procedure I - C	Storage: -65 °C to 135 °C; 12 cycles
Rain	506.5 - Procedure I	Wind Blown Rain
Immersion	512.5 - Procedure I	Non-Operating
Humidity	507.5 - Procedure II	Aggravated cycle @ 95% RH (Figure 507.5-7 aggravated temp - humidity cycle, 15 cycles)
Random Vibration	514.6 - Procedure I	10 - 2000 Hz, PSD level of 1.5 g ² /Hz (54.6 g _{rms}), duration = 1 hr/axis
Shock	516.6 - Procedure I	20 g peak, 11 ms, Functional Shock (Operating no load) (saw tooth)
	516.6 - Procedure VI	Bench Handling Shock
Sinusoidal vibration	514.6 - Category 14	Rotary wing aircraft - helicopter, 4 hrs/axis, 20 g (sine sweep from 10 - 500 Hz)
Sand and Dust	510.5 - Procedure I	Blowing Dust
	510.5 - Procedure II	Blowing Sand



MPFIC-U-28-HT
Input:85-264Vrms
Output:28Vdc
Current:11.5A

Application Section

Basic Operation & Features

The MPFICQor isolated power factor correction module is a high efficiency, high power AC-DC converter. It operates from a universal AC input to generate an isolated DC output voltage. Both regulated and semi-regulated (droop version) modules are available. As shown in Fig. A, a typical power supply would be comprised of a SynQor MCOTS AC Line Filter, a SynQor MPFICQor module and an energy storage hold-up capacitor. A fuse is needed to meet safety requirements.

One of the primary purposes of the MPFICQor is to shape the input current that is drawn from a single-phase sinusoidal AC source into a nearly perfect sinusoidal waveform so that the AC-DC power supply will present a very high power factor load (PF > 0.99) to this source. In doing this wave-shaping, the MPFICQor ensures that the harmonic components of the AC current waveform are below the levels called for in military standards such as MIL-STD-1399 and MIL-STD-704. The total harmonic distortion of the AC current waveform is typically 3% at full load.

The MPFICQor accomplishes its wave-shaping task by first rectifying the filtered AC source voltage, and then processing the input power through a non-isolated, high-efficiency, high-frequency “boost converter” that both gives the input AC current its sinusoidal shape and provides a regulated DC voltage across the hold-up capacitor. This stage is then followed by a highly efficient, fixed duty cycle isolation stage, which provides the isolated output voltage. For regulated output modules, the output voltage is sensed and this information is sent to the primary side control circuitry through a digital isolator. The DC voltage across the hold-up capacitor is then adjusted to keep the output voltage regulated.

The hold-up capacitor handles the cyclic imbalance between the flow of energy drawn from the AC source and the flow of energy delivered to the load. This energy imbalance has a cyclic frequency twice that of the AC source voltage (e.g. 120Hz for a 60Hz input). This relatively low frequency makes the hold-up capacitor relatively large. Another purpose of the hold-up capacitor is to be a source of energy so that the output can continue to deliver load power during a temporary brownout or dropout of the AC source. A typical power supply will have sufficient hold-up capacitor to give a “hold-up time” in the 20ms range, but longer times can be achieved with yet more hold-up capacitance.

Besides shaping the AC current waveform, the MPFICQor performs several other important functions. At start-up it controls the level of inrush current drawn from the AC source to charge the hold-up capacitor. It limits the DC current that can be drawn from the hold-up terminals and it will shut-down if a short circuit appears across the hold-up terminals. It will also shut-down if the

AC input voltage is out of its range (either too high or too low) for too long, or if the temperature of the module is too high.

In addition, the MPFICQor has several input control signals that include `PFC_ENABLE`, `AC_GOOD`, and `DC_GOOD`. All of these signals are described in more detail below. There is also an auxiliary bias supply that can be used to power a low power control circuit. All control signals and AUX are referenced to HU-.

Start-Up Sequence

When the AC source voltage is first applied, regardless of whether the MPFICQor is enabled or disabled through its `PFC_ENABLE` pin, the MPFICQor will pre-charge the output hold-up capacitor with a current limited to approximately 50mA. This pre-charging continues until the hold-up voltage is within approximately 10V of the peak voltage of the AC source. If, at this time, the `PFC_ENABLE` input is logically high, and the MPFICQor is therefore disabled, the MPFICQor will remain in this pre-charged state indefinitely. The output voltage will remain at 0V.

When the `PFC_ENABLE` input pin is pulled low, and after the pre-charging is completed if it is not already, the boost converter within the MPFICQor will start operating and the MPFICQor’s hold-up voltage will be increased to its nominal regulated value. After this regulated voltage level is achieved, the isolation stage within the MPFICQor will then start operating. The converter’s output voltage will rise to its nominal value.

If the `PFC_ENABLE` input is de-asserted (pulled high or allowed to float), the boost converter, as well as the isolation stage, in the MPFICQor will shut down.

NOTE: The voltage across the hold-up capacitor will remain in a charged state after the MPFICQor is disabled as long as the AC source voltage is present.

Brownout/Dropout Sequence

If the AC source voltage is present but it is below its continuous minimum input voltage limit, the MPFICQor will still draw whatever power it can (within its current limit) from the AC source. This power may not be enough for the total load power, in which case the hold-up capacitor will provide the balance of the power. The voltage across the hold-up capacitor and output voltage will therefore drop as hold-up capacitor discharges.

If the AC source voltage drops below its specified transient minimum input voltage limit, the MPFICQor’s boost converter



MPFIC-U-28-HT
Input: 85-264Vrms
Output: 28Vdc
Current: 11.5A

Application Section

will shut down and no longer deliver power to the output. Under this condition, all of the load power will be drawn from the hold-up capacitor.

If and when the voltage across the hold-up capacitor drops below its specified minimum limit, the isolation stage will stop operating and output will be turned off. This condition will cause the MPFICQor to return to the beginning of the startup sequence described above.

NOTE: Regardless of what happens to the MPFICQor’s hold-up voltage under a brownout or dropout condition, if the AC source voltage drops below its rated under-voltage value for 1 second or more, the MPFICQor will shut down.

If, however, the voltage across the hold-up capacitor does not drop below its specified minimum limit before the AC source voltage returns to within its continuous operating range (and it hasn’t been absent for more than 1 second), the MPFICQor will automatically re-establish its power flow. The hold-up capacitor will be recharged immediately to the peak of the AC source voltage (if it has fallen below this value) and to its nominal regulated voltage level within a few cycles of the AC source waveform.

NOTE: During the first phase where the hold-up capacitor is recharged (if this phase exists) there will be an inrush current drawn from the AC source that depends on the details of how quickly the AC source voltage returns to its normal operating condition.

Control Features

Auxiliary Power Supply (AUX):

The circuit shown below is an effective model for the AUX bias power supply:

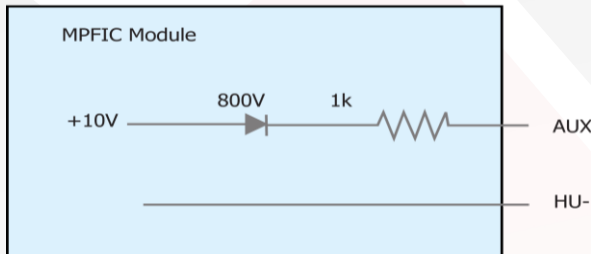

The purpose of the AUX power supply is to provide a low level of power to primary control circuitry, referenced to HU-.

The AUX power supply is present and regulated whenever the MPFICQor’s hold-up voltage is greater than approximately 75V. The AUX bias power supply is unspecified when MPFICQor’s hold-up voltage is less than about 75V (it may, for instance, come and go as the hold-up voltage rises on its way to 75V).

PFC_ENABLE:

The MPFICQor uses the following circuit for this input logic signal:

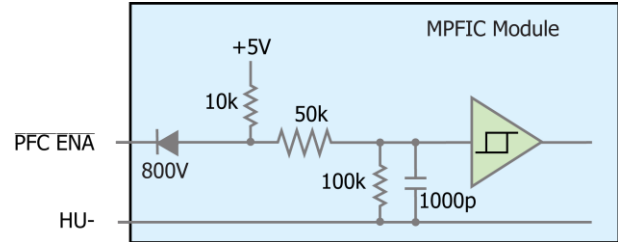

- If this input is floating or tied high the MPFICQor’s boost converter and its isolation stage are disabled.
- If this input is pulled low the MPFICQor’s boost is enabled after the pre-charger has charged the voltage across the hold-up capacitor to within approximately 10 volts of the peak of the AC source voltage. Isolation stage is turned on after hold-up voltage reaches regulation.

AC_GOOD:

The MPFICQor uses this circuit for this output logic signal:

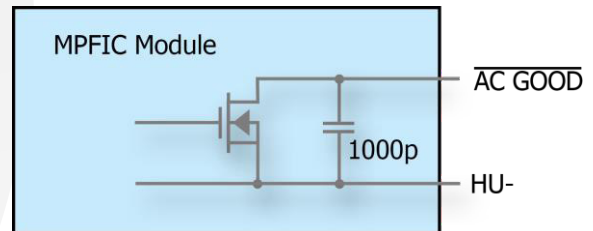

- The AC_GOOD signal is internally pulled low whenever the AC source voltage is within the MPFICQor’s continuous operating range for at least one cycle of the source waveform, regardless of whether the MPFICQor is enabled or disabled.
- When the peak of the AC source voltage is outside this continuous operating range (either too high or too low), the AC_GOOD pin will float.
- The AC_GOOD signal is typically used with a pull-up resistor and an opto-coupler (as shown in Fig. A) to provide an isolated signal to the load that the AC source voltage is no longer within the specified continuous operating range. If this condition persists, the load power can only be delivered for the “hold-up time”, and it may therefore be desirable to have the load gracefully shut down. The AC_GOOD signal provides a warning for this action to be

Application Section

taken. When the AC source voltage returns to the specified continuous operating range, the $\overline{\text{AC_GOOD}}$ signal will re-assert after a 100 ms delay.

- The $\overline{\text{AC_GOOD}}$ pin is valid whenever the AUX bias supply power is valid (see above).

DC_GOOD:

The MPFICQor uses this circuit for this output logic signal:

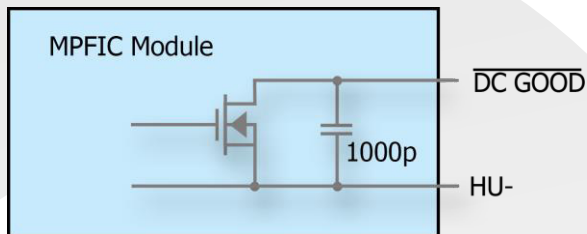

- The $\overline{\text{DC_GOOD}}$ signal is internally pulled low whenever the output voltage has reached regulation. The $\overline{\text{DC_GOOD}}$ signal is typically used with a pull-up resistor and an opto-coupler (as shown in Fig. A) to provide an isolated signal to the load.
- When multiple droop version units are used in parallel for higher power applications, the load should not exceed the rating of a single module until all of the individual $\overline{\text{DC_GOOD}}$ outputs have been asserted low.

Protection Features

Input Over- and Under-Voltage:

If the AC source voltage exceeds the maximum peak voltage rating defined in the electrical specifications, the MPFICQor will shut down. However, under this condition the MPFICQor's pre-charge circuit will continue to deliver 50mA of current to the hold-up capacitor whenever the AC source voltage is higher than the hold-up voltage. Care must be taken to insure this condition does not allow the hold-up voltage to rise high enough to damage the MPFICQor.

If a brownout or dropout of the AC source voltage occurs, and if it lasts long enough for the MPFICQor's hold-up voltage to drop below its specified minimum limit, the MPFICQor will shut

down. Furthermore, regardless of what happens to the MPFICQor's hold-up voltage, if the AC source voltage drops below its rated under-voltage value for 1 second or more, the MPFICQor will shut down.

After any shutdown, the MPFICQor will automatically return to the beginning of the startup sequence described above.

Hold-up Over-Voltage:

If the hold-up voltage exceeds its specified maximum limit, the MPFICQor will remain active, but will stop delivering power through its main boost stage until the hold-up voltage falls below the over-voltage threshold. Under this condition, the isolation stage will remain active and provide output voltage.

The MPFICQor's pre-charge circuit will continue to deliver 50mA of current to the hold-up whenever the AC source voltage is higher than the hold-up voltage. Care must be taken to ensure this condition does not allow the hold-up voltage to rise high enough to damage the MPFICQor.

Output Current Limit and Short-Circuit Shutdown:

If the MPFICQor's output is overloaded such that its output current limit becomes activated, the output voltage will fall as the excess load current discharges the hold-up capacitor. The MPFICQor will continue to deliver power into this overload condition for 1s, after which the unit will shut down and automatically return to the beginning of the startup sequence described above. In above situations, both boost and isolation stage will turn off.

The MPFICQor responds to a short-circuit event by turning the isolation stage off. The output voltage of the MPFICQor will drop to zero. During the short circuit event, the boost converter will continue to run and the hold-up capacitor will remain charged. The module then enters a hiccup mode where it repeatedly turns on and off until the short-circuit condition is removed. This prevents excessive heating of the converter.

The off time during a short-circuit event is a function of input frequency. For 50/60Hz input, off time equals 25 line cycles. For example, at 60Hz, off time is:

$$T_{off(60\text{Hz})} = \frac{25}{60} = 417\text{ms}$$

For 400Hz input, off time is 200 line cycles:

$$T_{off(400\text{Hz})} = \frac{200}{400} = 500\text{ms}$$

Application Section

Over Temperature:

If the internal temperature of the MPFICQor reaches 130°C, the MPFICQor will turn off its boost converter and isolation stage. When the internal temperature falls below 110°C, the MPFICQor will return to the beginning of the startup sequence described above.

Energy Storage Hold-Up Capacitor

The hold-up capacitor performs two functions:

- It handles the cyclic imbalance between the flow of energy drawn from the AC source and the flow of energy delivered to the load. In doing so, the voltage across the hold-up capacitor has a ripple at a frequency twice that of the AC source voltage (e.g. 120Hz for a 60Hz input). The larger the hold-up capacitor, or the higher the frequency of the AC source, the smaller this ripple will be.
- It provides a source of energy so that the MPFICQor can continue to deliver load power during a temporary brownout or dropout of the AC source. The larger the hold-up capacitor the longer it can provide this energy. Often it will be made large enough to allow the load to be gracefully shutdown after the AC source has been outside of its normal range for a set amount of time. A typical “hold-up time” would be in the 20 ms range for a 50/60 Hz system.

The total energy stored in a hold-up capacitor having capacitance C at any given voltage V is:

$$E = \frac{1}{2}CV^2$$

The amount of energy, ΔE , which can be drawn from this capacitor depends on the capacitor’s initial voltage, V_i , and its final voltage, V_f . This energy equals the amount of power, P, which the load draw through the isolation stage from the hold-up capacitor times the length of time, Δt , which it takes for the hold-up capacitor’s voltage to drop from V_i to V_f . This energy can be equated to the hold-up capacitance according to the following formula:

$$\Delta E = \frac{P}{\eta_{ISO}}\Delta t = \frac{1}{2}C(V_i^2 - V_f^2)$$

In this formula, P is the load power and $\eta_{ISO} = 96\%$ is the isolation stage efficiency. This formula can be rearranged to find the minimum required value for C to provide the hold-up time desired for a given power level.

$$C_{min} = 2\frac{P}{\eta_{ISO}}\Delta t / (V_i^2 - V_f^2)$$

For example, if we assume $P = 300W$, $\Delta t = 20ms$, $V_i = 400V$, $V_f = 300V$, and $\eta_{ISO} = 96\%$, then we would want a hold-up capacitance of at least 180 μF .

NOTE: In the above example, the hold-up voltage drops by 25% at the end of brownout period. This also means the output voltage will drop by 25%. More hold-up capacitance is recommended if the secondary output voltage needs to be maintained at a higher level.

NOTE: The MPFICQor is able to operate with a minimum of 50 μF of hold-up capacitance, but SynQor recommends at least 330 μF if the power system will be required to conform to lightning surge standards. This is because the MPFICQor relies on the hold-up capacitor to absorb most of the energy from a lightning surge.

NOTE: Even though the MPFICQor limits the inrush current drawn from the AC source during its startup sequence, it will not necessarily limit this current at the end of a temporary brownout or dropout of the AC source when the hold-up capacitor’s voltage has not dropped below its minimum hold-up voltage limit. In such a condition the MPFICQor will not reinitiate a startup sequence and it will therefore not limit the current flowing through it. If the peak of the AC source voltage is greater than the hold-up capacitor’s voltage at the end of the brownout/dropout period, there will be a large inrush current for one half-cycle as the hold-up capacitor’s voltage is charged up to the peak of the AC source voltage. The larger the hold-up capacitor, the larger this inrush current will be. To limit inrush current during this event, limit the charging current of additional hold-up capacitance with a resistor and diode as shown below.

If it is desired to have a hold-up time longer than can be achieved with the maximum specified hold-up capacitance, then the circuit shown below can be used.

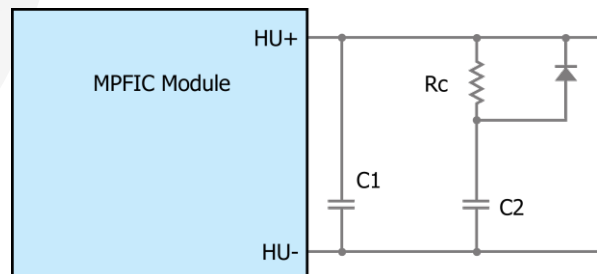

In this circuit the total hold-up capacitance is $(C1 + C2)$, and it can be made as large as desired as long as C1 does not exceed the maximum capacitance specified in the Technical Specifications table. The resistor, R_c , in series with C2 is present to limit the current that will charge this capacitor after a temporary brownout/dropout event. Its resistance should be large enough to limit the charging current. The diode in parallel with the resistor permits the load converters to draw whatever energy they need from C2 without being hindered by the resistor.

Application Section

Output Ripple Considerations:

The hold-up capacitor must have a ripple current rating high enough to withstand the ripple current generated on the hold-up capacitor of the MPFICQor. Ripple current amplitude is dependent only upon the total MPFICQor output power, P_{DC} , isolation stage efficiency $\eta_{ISO} = 96\%$, and the operating hold-up voltage $V_{HU} = 400V$. It can be calculated using the following formula:

$$I_{Crms} = \frac{P_{DC}}{\sqrt{2} \cdot \eta_{ISO} \cdot V_{HU}} = \frac{P_{DC}}{543}$$

The AC line frequency, f_{ac} , bulk capacitance, C , operating hold-up voltage, and output power will determine the amplitude of the voltage ripple present on the output of the MPFICQor. It can be calculated with:

$$V_{pk-pk} = \frac{P_{DC}}{2\pi \cdot \eta_{ISO} \cdot f_{ac} \cdot C \cdot V_{HU}}$$

$$\text{At 60 Hz: } V_{pk-pk} = \frac{P_{DC}}{1.47 \cdot 10^5 \cdot C}$$

For example, to calculate the hold-up capacitor's voltage and current ripple for a MPFICQor with a 300W output, 250 μ F hold-up capacitor, and a 60Hz fundamental AC line frequency:

$$I_{Crms} = \frac{300W}{543} = 0.55A_{rms}$$

$$V_{pk-pk} = \frac{300W}{2\pi \cdot 0.96 \cdot 60 \cdot 250 \cdot 10^{-6}F \cdot 400V} = 8.3V_{pk-pk}$$

In this case, the hold-up capacitor would require a minimum ripple current rating of 0.55A_{rms}, and the hold-up voltage would have a pk-pk ripple voltage of 8.3V, or 2%. Since the isolation stage is fixed duty cycle, the secondary output voltage will also have a 2% ripple at 2x the line frequency.

Safety Notes

The output of the MPFICQor is isolated from the AC source. But the hold-up voltage and the control signals are primary-side referenced and are therefore hazardous voltages. Care must be taken to avoid contact with primary-side voltages, as well as with the AC source voltage.

The MPFICQor must have a fuse in series with its AC source. The rating for this fuse is given in the Technical Specification table.

Thermal Consideration

The maximum operating base-plate temperature, T_B , is 100°C. Refer to the thermal derating curves to see the allowable power output for a given baseplate temperature and input voltage. A power derating curve can be calculated for any heatsink that is attached to the base-plate of the converter. It is only necessary to determine the thermal resistance, R_{THBA} , of the chosen heatsink between the base-plate and the ambient air for a given airflow rate. The following formula can then be used to determine the maximum power the converter can dissipate for a given thermal condition:

$$P_{diss}^{max} = \frac{T_B - T_A}{R_{THBA}}$$

This value of power dissipation can then be used in conjunction with the data shown in the figures to determine the maximum load power that the converter can deliver in the given thermal condition.

MIL-STD-704 Power Level & Power Factor

All versions of MIL-STD-704 state that single-phase loads must draw less than 500VA of AC power. The MPFIC's maximum output power complies with this requirement.

Section 5.4.3 of MIL-STD-704F states that AC equipment drawing greater than 100VA shall have no leading power factor. Most electronic loads, including the SynQor MPFIC, contain a small amount of differential filter capacitance across the AC input, which draws a small amount of leading reactive power. This has a negligible effect on the power factor of the MPFIC when it is drawing significant real power. Nevertheless, a small amount of leading power factor exists, and an exception to MIL-STD-704F section 5.4.3 must be taken or a compensating parallel inductor must be included. Use Figures 5 to determine the amount of leading power factor and ensure compatibility with the target AC power system.

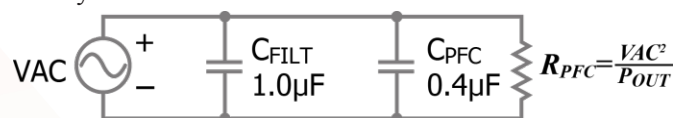

Application Section

- C_{FILT} = MACF filter effective differential capacitance
- C_{PFC} = MPFIC effective differential capacitance
- R_{PFC} = MPFIC load
- P_{OUT} = MPFIC total output power

This is an approximate representation of the input stage of the MPFIC and MACF filter for the purpose of calculating the leading reactive power and power factor. The resistor represents the in-phase current and its value varies with the load power. The capacitors represent the reactive current draw and are approximately constant over load.

MCOTS AC Line Filter

An AC line filter is needed to attenuate the differential- and common-mode voltage and current ripples created by the MPFICQor and the load, such that the system will comply with EMI requirements. The filter also provides protection for the MPFICQor from high frequency transients in the AC source voltage. SynQor has a family of AC line filters that will provide these functions. It is recommended that a metal-oxide varistor (MOV) be placed from line-to-line on the input of the filter, and a TVS diode be placed from line-to-line on the output of the filter in order to keep the MPFICQor input voltage from exceeding 450V during all transients, except when the PFC is disabled, when the input can tolerate 575V transients for up to 100ms. See Figure A for example parts. If a non-SynQor AC line filter is used, the use of an MOV on the input and a TVS diode on the output of the filter is still recommended.

EMI Considerations

To meet various conducted line emission standards, additional Y-capacitors may be needed to attenuate common-mode noise. SynQor recommends that safety-rated ceramic capacitors be placed from HU- to Vout- and Vout- to ground. However, the total capacitance from the MPFIC HU- leads to earth ground should not be more than 20nF if one of the MPFIC input leads is connected to earth ground. See “Typical Application of the MPFIC Module” (Figure A) for a diagram and suggested parts.

Paralleling Multiple MPFICQors

In higher power applications, multiple droop version units can be used in parallel.

- Only droop version units can be used in parallel. Current share is accomplished by passive droop sharing method.
- On startup, total load should not exceed the rating of a single module until all of the individual DC_GOOD outputs have been asserted low.

Operation at High Input Voltages

If the AC input voltage exceeds about 250 Vrms, both the hold-up voltage and output voltage will be raised up in order to maintain proper input current power factor correction. Output voltage can increase by up to 15% from the nominal output set point as input voltage increases from 250 Vrms to 264 Vrms.



MPFIC-U-28-HT
Input: 85-264Vrms
Output: 28Vdc
Current: 11.5A

Encased Mechanical

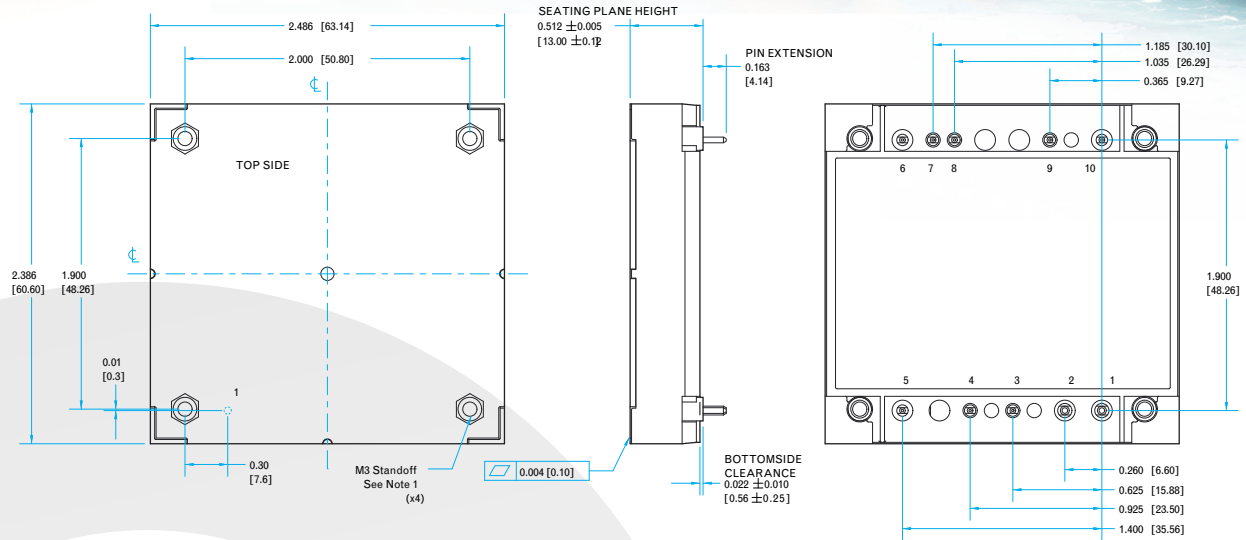

NOTES

- 1) Applied torque per M3 screw should not exceed 6in.-lb. (0.7 Nm).
- 2) Baseplate flatness tolerance is 0.004" (.10 mm) TIR for surface.
- 3) Pins 1 and 2 are 0.062" (1.57mm) diameter with 0.100" (2.54mm) diameter standoff shoulder
- 4) Pins 3-10 are 0.040" (1.02mm) diameter, with 0.080" (2.03mm) diameter standoff shoulders.
- 5) All Pins: Material - Copper Alloy; Finish - Matte Tin over Nickel plate
- 6) Undimensioned components are shown for visual reference only.
- 7) Weight: 4.8 oz (136 g)
- 8) Threaded and Non-Threaded options available
- 9) All dimensions in inches (mm).
Tolerances:
x.xx +/-0.02 in. (x.x +/-0.5mm)
x.xxx +/-0.010 in. (x.xx +/-0.25mm)
unless otherwise noted.
- 10) Workmanship: Meets or exceeds IPC-A-610C Class II

PIN DESIGNATIONS

Pin	Name	Function
1	VOUT+	Positive Output Voltage
2	VOUT-	Negative Output Voltage
3	L1	AC Line 1
4	PFC ENA	Negative Logic PFC Enable, Referenced to HU-
5	L2/N	AC Line 2 / Neutral
6	AC GOOD	Negative Logic AC Good Signal, Referenced to HU-
7	DC GOOD	Negative Logic DC Good Signal, Referenced to HU-
8	AUX	Auxiliary Bias Power Supply, Referenced to HU-
9	HU-	Negative Hold-up Voltage
10	HU+	Positive Hold-up Voltage

Encased Mechanical with Flange

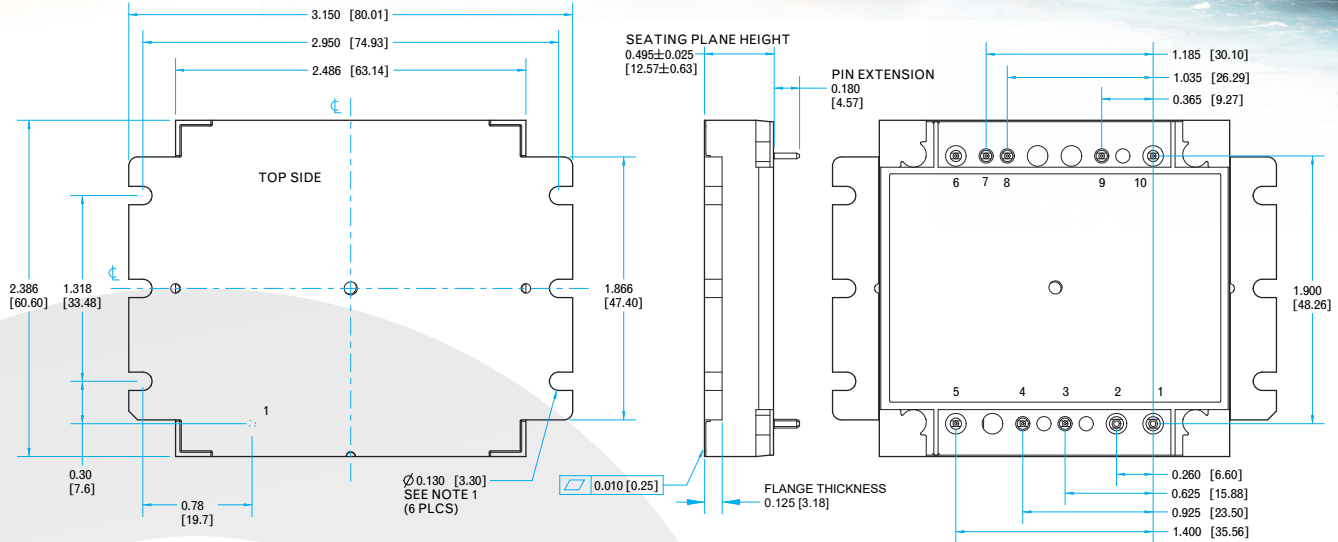

NOTES

- Applied torque per M3 or 4-40 screw should not exceed 6in-lb. (0.7 Nm).
- Baseplate flatness tolerance is 0.010" (.2mm) TIR for surface.
- Pins 1 and 2 are 0.062" (1.57mm) diameter with 0.100" (2.54mm) diameter standoff shoulder
- Pins 3-10 are 0.040" (1.02mm) diameter, with 0.080" (2.03mm) diameter standoff shoulders.
- All Pins: Material - Copper Alloy; Finish - Matte Tin over Nickel plate
- Undimensioned components are shown for visual reference only.
- Weight: 5.0 oz (142 g)
- All dimensions in inches (mm).
Tolerances:
x.xx +/-0.02 in. (x.x +/-0.5mm)
x.xxx +/-0.010 in. (x.xx +/-0.25mm)
unless otherwise noted.
- Workmanship: Meets or exceeds IPC-A-610C Class II

PIN DESIGNATIONS

Pin	Name	Function
1	VOUT+	Positive Output Voltage
2	VOUT-	Negative Output Voltage
3	L1	AC Line 1
4	PFC ENA	Negative Logic PFC Enable, Referenced to HU-
5	L2/N	AC Line 2 / Neutral
6	AC GOOD	Negative Logic AC Good Signal, Referenced to HU-
7	DC GOOD	Negative Logic DC Good Signal, Referenced to HU-
8	AUX	Auxiliary Bias Power Supply, Referenced to HU-
9	HU-	Negative Hold-up Voltage
10	HU+	Positive Hold-up Voltage



MPFIC-U-28-HT
Input: 85-264Vrms
Output: 28Vdc
Current: 11.5A

Ordering Information

Ordering Information / Part Numbering Scheme

Family	Input Voltage	Output Voltage	Package Size	Thermal Design	Screening Level	Option
MPFIC	U: 85-264V	12: 12V 24: 24V 28: 28V 48: 48V	HT: Half-brick Tera	N: Encased D: Encased with Non-threaded Baseplate F: Encased with Flanged Baseplate	S: S-Grade M: M-Grade	[]: Standard D: Droop

Example: **MPFIC-U-28-HT-N-M**

PART NUMBERING SYSTEM

The part numbering system for SynQor's ac-dc converters follows the format shown in the example.

APPLICATION NOTES

A variety of application notes and technical white papers can be downloaded in pdf format from our website.

STANDARDS COMPLIANCE

Input to output isolation 4250Vdc	Reinforced Insulation
Input/Output to baseplate isolation 2150Vdc	Basic Insulation to Baseplate
CE Marked	

Note: An external input fuse must always be used to meet these safety requirements.

Contact SynQor for official safety certificates on new releases or download from the SynQor website.

Contact SynQor for further information and to order:

Phone: 978-849-0600 Toll Free: 888-567-9596 Fax: 978-849-0602

E-mail: power@synqor.com Web: www.synqor.com

Address: 155 Swanson Road, Boxborough, MA 01719 USA

WARRANTY

SynQor offers a two (2) year limited warranty. Complete warranty information is listed on our website or is available upon request from SynQor.

PATENTS

SynQor holds numerous U.S. patents, one or more of which apply to most of its power conversion products. Any that apply to the product(s) listed in this document are identified by markings on the product(s) or on internal components of the product(s) in accordance with U.S. patent laws. SynQor's patents include the following:

7,765,687 7,787,261
 8,149,597 8,644,027